

UC | ONE FOR ALL.

The perfect undercounter warewasher



A machine for perfect cleanliness and hygiene. Perfectly coordinated accessories. Specially developed chemicals. Advice and personal support. Planning expertise and training courses. Monitoring, reporting and service. All that and more from Winterhalter.

SEE FOR YOURSELF.

Glasses. Dishes. Cutlery. Sheet pans and trays. Baker's and butcher's boxes. Ample or limited room. With or without water softener. The idea behind the UC Series is simple: Matched to your needs and requirements. One for all. Configurable so that a customised solution is the end result. Your dream machine.



UC-S



UC-M



UC-L



UC-XL

MACHINE SIZES

For ample or limited room. The UC Series allows you to select precisely the machine size that best fits the space available to you and your wash items. And for all sizes: There is, of course, the right rack for every type of application.



UC-L

SMART TOUCH DISPLAY

for intuitive and simple operation

CONNECTED WASH

digital connectivity for greater safety and efficiency

INNOVATIVE WASH FIELD

flow-optimised and with new nozzle geometry: reduces water consumption by up to 25 %



The UC's mission: sparkling glasses, spotless dishes and gleaming cutlery. And hygienically clean bottles and reusable plastic cups. For that satisfied smile on your guests' faces.

CUSTOMISED SOLUTION

Made for you: the UC comes to you as a glass, dish, cutlery, bistro, bottle or plastic cup washer depending on the application. Every machine has up to three standard programmes, which you can set to adapt the wash to suit individual characteristics, such as the level of soiling.

PERFECT WASH RESULTS

Sparkling bright. Hygienically clean. Visibly spotless. The UC guarantees perfect wash results and offers you the very highest standards of hygiene safety. This is confirmed by the DIN SPEC 10534 hygiene certificate.

ECONOMICAL AND EFFICIENT

The UC Series is economical and cost-effective to operate: The S-shaped wash field ensures optimal and even distribution of the water, which significantly reduces water consumption during rinsing. Consumption of electricity and chemicals also drops as a result – further minimising the overall operating costs.

USER-FRIENDLY

A smart touch display with programme selection, progress indicator and short explanatory videos. Ergonomic door handle. And particularly easy cleaning, with two wash fields that can be removed with one hand at the push of a button – entirely without the use of tools. You will appreciate the easy and intuitive operation of the UC.



A detailed overview of the UC Series is available on our website at:

>> www.winterhalter.co.uk/uc

You can find detailed information relating to the UC as a special glasswasher on our website at:

>> www.winterhalter.co.uk/glasswasher



FLEXIBLE MACHINE DESIGN

The basic concept of the UC has proven itself over many years and has made the series extremely successful: one machine technology for six different applications. The UC can be customised precisely to meet specific needs: as a glass, dish, cutlery, bistro, bottle or plastic cup washer. And should the preferred application change: The service technician will be happy to reconfigure the machine for you, and turn a glasswasher, for example, into a bistro warewasher. In addition to its standard programme, the UC also offers a whole range of special programmes. For example there's a basic cleaning programme, a soaking programme and an intensive programme for particularly heavy and stubborn soiling as well as short programmes for when things have to be done quickly. The ECO programme can be used for particularly economical operation, and the Silence programme can be selected for an extra quiet cycle – ideal in the counter area. There are also programmes for self-cleaning, tank water change and descaling.

SMART TOUCH DISPLAY

Ready for the future: A smart touch display is at work in the UC cockpit. A language-neutral user interface with self-explanatory pictograms and fault messages in 22 different languages makes operating the machine easier. The timer function can programme the UC to switch on or off automatically at a specific time. The display reacts sensitively and can also be reliably operated in gloves. The surface is made of glass and is particularly robust: It has been tested under extreme conditions.

VARIOPOWER: THE RIGHT PRESSURE FOR EVERY WASH ITEM

This ensures that light dishes remain securely in place, while heavier dishes can be washed with increased pressure: VarioPower – the automatic variable water pressure regulation – ensures that the washing parameters, depending on the selected programme, are adjusted to the dishes.

EFFICIENT FILTRATION

The cleaner the wash water, the fewer changes of water are required – and the better the wash result. That's why the UC Series is equipped with an effective quadruple filtration system. During stage 1, a strainer filters the largest dirt particles out of the wash water. During stage 2, the filter cylinder with a fine filter removes smaller dirt particles. The Mediamat then filters out the finest particles, such as coffee grounds, during stage 3. Finally, during stage 4, the filter bottom protects the wash pump from mechanical damage.

SOPHISTICATED HYGIENE CONCEPT

The UC is fitted with numerous additional features that guarantee maximum hygiene: for example, the machine's hygiene design with a deep-drawn rack guide and deep-drawn tank with hygienic tank heater. And the Thermostop, which only starts the rinse once the necessary rinse water temperature has been reached to achieve a hygienic wash result. The integrated hygiene logbook documents compliance with the regulations and ensures verifiable hygiene safety in accordance with DIN SPEC 10534.

CONNECTED WASH: GREATER SAFETY, GREATER EFFICIENCY

Every UC has a WLAN function on board as standard. This allows for the machine to be networked with a computer or mobile device via CONNECTED WASH. This creates the prerequisite for the analysis and evaluation of all the important operating data – in order to optimise the entire washing process. Simultaneously, the UC automatically receives all important updates so that its software is always right up-to-date.

HEAT RECOVERY

Intelligent use of energy: As an option, the UC can be fitted with Energy integrated circulating air heat recovery. This uses the energy from the hot steam to pre-heat the cold inlet water. This significantly reduces energy consumption, lowers operating costs and ensures that hardly any steam escapes when the machine is opened.

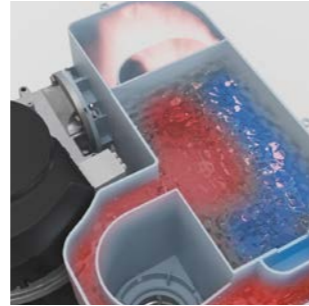

② In the heat exchanger, the cold inlet water is pre-heated by the energy from the warm steam.



① After the wash cycle, the warm steam is automatically extracted from the interior of the machine.

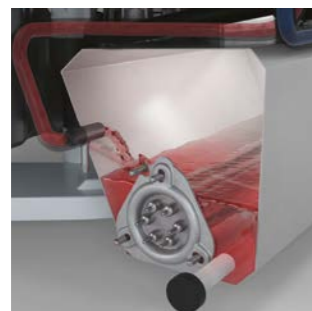

③ The pre-heated inlet water is transferred to the boiler and no longer needs to undergo a full heating cycle.

WATER TREATMENT

Deposits. Streaks. Marks. They are »little greetings from the kitchen« and the natural enemies of any restaurateur. This is because they are indicative of poor washing quality. As limescale impairs the effect of detergent and rinse aid, and damages the machine in the long-term. The problem is water quality – the solution is professional water treatment.

Winterhalter has developed an entire product range from simple water softening, via partial or full demineralisation, through to reverse osmosis. Integrated into the machine or as an external device. And always tailored precisely to your needs and the local water quality. The result is sparkling glasses without any need to polish, radiant cutlery und shining plates.



The external and internal reverse osmosis solution from Winterhalter: AT Excellence-S, AT Excellence-M, UC-S Excellence-i/Plus and UC-M Excellence-i/Plus.

REVERSE OSMOSIS

For the highest standards in water quality there is the »UC Excellence-i« with built-in reverse osmosis. It produces sparkling glasses and shining cutlery – without any need to polish. In the UC Excellence-iPlus, which has an additional integrated softener, glasses can be washed with osmosis water and dishes with softened water thanks to the VarioAqua function.

The external reverse osmosis devices AT Excellence-S and AT Excellence-M are winning customers with their consistent delivery of perfect wash results. Thanks to the AquaOpt function, water is treated until it reaches the desired quality following each wash break. The operational status of AT Excellence devices is shown on the warewasher display.

INTEGRATED SOFTENER

For better wash results and to protect the machine: Every UC has an optional integrated softener. It is built into the machine to save space and provides continuous soft water. This way, detergent and rinse aid can have an optimum effect, which significantly reduces limescale deposits in the machine.

»For us, a whole range of different items need to be washed. That is why we decided on a high-performance combination from the outset: A UC-XL for dishes and a GN container, as well as a UC-S for glasses and cutlery. The right decision from the very start: The quality, reliability and the customer service from Winterhalter never cease to impress us!«

Michail Loukidis, CULINARY MANAGER, ROTH ENERGIE | ALLENDORF



Note: the product illustrations are customer-specific configurations that may also include products from other manufacturers.

Cleanliness and hygiene. Every single one of our products plays its part. Together they create the perfect wash result. Welcome to the complete Winterhalter system!

WASH RACKS

They are custom-made for glasses, dishes or cutlery. With their functional design they adapt precisely to the respective wash items, protecting them and preventing damage. They ensure ideal water and air circulation and fast drying. They make handling and transporting wash items easier. Plus: Special solutions such as the double-rack system enable you to wash on two levels with just one wash cycle ensuring greater flexibility.

Wash racks have a decisive influence on the quality of the wash result and the total operating costs. We will be happy to advise you on which racks best suit your requirements. Culminating in the best solution for you.



CHEMICALS

Washing is essentially about two things: perfect cleanliness and maximum hygiene. Chemicals have a decisive influence on both. This is the reason they are an important component of the overall Winterhalter system.

Many years ago at our German headquarters, we therefore established a research and development department with an in-house laboratory. Here we develop and test formulae for a premium range of detergents and hygiene products. These are precisely tailored to the different wash items and types of contaminants, economical to use, and they can be ideally combined with other products in our range. They work together perfectly and deliver first-class wash results.



DOSING TECHNOLOGY

Perfect wash results. A consistently high quality over a long period. Operating costs that are as low as possible. Optimal dosing of the chemicals has numerous advantages. Optimal dosing means: dosing that is precisely adapted to the water hardness, the wash items and the level of soiling. There is a special Winterhalter suction tube for this: It supports the precise dosing of detergent and rinse aid from the container – with automatic level monitoring and an empty alert on the machine display.

The UC is also available with integrated containers for detergent and rinse aid. No additional space is required, and there are no containers left around in the kitchen.



PLINTHS

You would like to have your UC at an ideal working height and create additional storage room? For example, in order to store your wash racks under the machine to save space? Would you rather keep wash racks or detergent and rinse aid containers tidied away under the machine? We've considered these options and developed special plinths for our under counter machines tailored to these requirements. Open and enclosed, in various heights, with and without a drawer. For ergonomic working and space-saving storage.

SUPPORT AND PLANNING

Winterhalter is the specialist in commercial warewashing systems. Our knowledge encompasses the widest range of kitchens in the world. We know which aspects are important when it comes to washing, and what has to be taken into consideration. Plus: we enjoy passing this knowledge and experience on to our customers.

Together we will analyse your work flows, plan your needs and ensure an optimal setup that suits you. We organise your washing operation, optimise the washing logistics and provide instruction and training sessions for your employees. When it comes to washing up, we're always there for you. And we help you to make your washing process as efficient as possible.

What can we do for you? Let's talk about it: Tel. 01908 359000 or sales@winterhalter.co.uk

»We are family people!«

Down-to-earth. Forward-looking. With a focus on family. The culture and values of our family have shaped the Winterhalter company for three generations. Close to staff, customers and partners. Long-term thinking with a view to the generations to come. Taking personal responsibility – all typically Winterhalter. We are proud of our family company. And we are pleased to grow a little more every day.



Karl Winterhalter



Jürgen Winterhalter



Ralph Winterhalter

THE FIRST WINTERHALTER



It all began in 1947: Karl Winterhalter established his own company in Friedrichshafen. He started by salvaging scrap metal from the war, which he used to manufacture household goods. Cooking pots and ovens, for example. A short time later he specialised, and in 1957 launched the GS 60 model: the first commercial warewasher from Winterhalter. That was the starting signal. Since then the company has always pursued a single goal: perfect wash results as part of an efficient washing process. With this holistic approach, Winterhalter has developed from a machine supplier to the full system provider of warewashing solutions it is today.

»Products, advice, service – three factors that intertwine seamlessly at Winterhalter. And that makes our customers feel safe in the knowledge that they have the right partner for any issue relating to the washing process.«

FROM WAREWASHER TO WAREWASHING SOLUTION

In days gone by, all we needed to do was deliver the new warewasher to our customer's kitchen on a hand truck. Now it's about the development of a new, individual warewashing solution, which is perfectly coordinated with the on-site situation and the special requirements and preferences of the customer. A solution of this type is based on clear analysis and planning. To achieve this, we visualise the room layout using state-of-the-art CAD software in 2D and 3D. For a bespoke and efficient washing process.

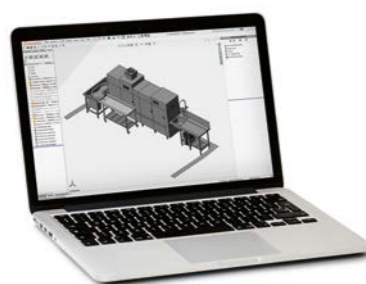

OVER 2.000

EMPLOYEES WORLDWIDE

High quality standards. Diligence. Curiosity and ambition. These are the typical attributes of a Winterhalter employee. And with them, we have grown from a small Swabian family company into a global player: with over 40 branches worldwide and distribution partners in over 70 countries. We are proud of what we have achieved. And we are proud of each and every employee who has done their bit. So we would just like to take this opportunity to officially say »Thank you!«



OUR ACADEMY OF WASHING SCIENCE

Almost 1,000 participants per year and 250 training days worldwide: as part of our training programmes we pass on our knowledge and experience in the discipline of »warewashing«. We provide training to our own personnel as well as to our retail and service partners. Our objective: every Winterhalter customer should receive informed advice and professional support in the specific situation. Whether it's an initial informative discussion, installing a warewasher, or service and maintenance appointments.

IN-HOUSE LABORATORY FOR IMPROVED CHEMICALS

As a specialist in warewashing, do we want to rely on the products of other manufacturers? The answer to this question was an immediate and resounding »No!«. This was the moment, when our in-house research and development laboratory was born: we have been developing our own formulas for original Winterhalter chemicals for many years now, from detergents and rinse aids to hygiene products.

Good to know

As a specialist in warewashing, at Winterhalter we set high standards for ourselves: we don't just want to meet our customers' current requirements. We want to support them proactively and gain their trust for the long term. Service plays an important role here: our comprehensive network guarantees fast and professional support on site. Worldwide.

We and our service partners are there when you need us. On that you can always rely with Winterhalter.



What opportunities does new technology offer? How is our society and the world of work changing? Which trends and developments will shape commercial warewashing in the future? We find all of these questions extremely exciting. And that's why we are already working on developments that will affect us and our customers tomorrow, and the day after that. You can take a look at the solutions that we have developed in our NEXT LEVEL SOLUTIONS. Current examples include CONNECTED WASH and PAY PER WASH.

>> www.connected-wash.com >> www.pay-per-wash.com

»See you again soon!«

Customers often own a Winterhalter warewasher for 15 or 20 years. So our customers only have to worry about disposing of their old equipment once every few decades. What's more, we take care of this ourselves. We design our machines as modular systems, so they are easy to dismantle if ever the need arises. We reduce the range of materials, use standardised construction materials and label plastic parts for easy recycling. Winterhalter warewashers have a particularly high recycling ratio thanks to these and many other measures.



MADE IN GERMANY AND SWITZERLAND

As ever, it is not simply an indication of origin, but a seal of quality: products made in Germany and Switzerland are recognised worldwide for their premium quality and reliability. For engineering, inventiveness and precision. Winterhalter is the best proof of this: in Meckenbeuren, Edingen and Rüthi, we develop and produce solutions for first-class cleanliness and hygiene. This is our promise for every single warewasher that leaves our factory.

TECHNICAL DATA

General data		UC-S	UC-M	UC-L	UC-XL
Tank capacity	l	9.5	15.3	15.3	15.3
Rack dimensions	mm	400 x 400	500 x 500	500 x 500	500 x 500 / 500 x 540
Clear entry height	mm	309	309	404	404
Wash pump	kW	0.6	0.6	0.6	0.6
Noise emission	dB(A)	max. 55			
IP protection class with plastic rear cover		IPX3	IPX3	IPX3	–
IP protection class with CN rear panel		IPX5	IPX5	IPX5	IPX5
Weight net / gross	kg	59 / 68	64 / 74	69 / 79	69 / 79
with Energy	kg	64 / 73	70 / 80	75 / 85	75 / 85
with Excellence-i	kg	79 / 88	85 / 95	–	–
Max. inlet water temperature	°C	60 (Energy: 20 / Excellence-i: 35)			
Required water flow pressure	bar / kPa	1.0 – 10.0 / 100 – 1.000			
with Energy	bar / kPa	1.5 – 10.0 / 150 – 1.000			
with UC Excellence-i	bar / kPa	1.4 – 10.0 / 140 – 1.000			

Specific data depending on software		Glasses	Dishes	Bistro	Cutlery
Theoretical capacity Standard *1	Racks / h	22 / 32 / 48	24 / 28 / 40	28 / 32 / 40	11
Theoretical capacity Short programme *1	Racks / h	77	66	66	21
Rinse water volume per wash cycle *2 UC-S	l	Standard: 2.0 Eco: 1.8 Cool: 3.4	Standard: 2.0 Eco: 1.8	Standard: 2.0 Eco: 1.8	Standard: 3.2 Eco: 2.9
Rinse water volume per wash cycle *2 UC-M, -L, -XL	l	Standard: 2.2 Eco: 2.0 Cool: 3.4	Standard: 2.2 Eco: 2.0	Standard: 2.2 Eco: 2.0	Standard: 3.4 Eco: 3.1
Tank temperature	°C	62 Cool: 55	62	62	69
Rinse water temperature	°C	65 Cool: *3	85	65 – 85	85
Rinse water temperature Energy *4	°C	65	65	65	65

ELECTRICAL DATA

Voltage	Fuse protection	Total connected load *5 Tank heating 1.8 kW Boiler heating 4.9 kW	Total connected load Cool *5 Tank heating 2.5 kW Boiler heating 4.9 kW	Countries
380V – 415V, 3N~, 50Hz/60Hz	10A	6.0 kW	–	Worldwide
	16A	7.9 kW	6.1 kW	
220V – 240V, 1N~, 50Hz/60Hz	10A	1.8 kW	–	
	13A	2.6 kW	–	
	16A	3.2 kW	3.4 kW	
	20A	4.1 kW	4.2 kW	
230V, 2~, 50Hz/60Hz	16A	3.0 kW	–	Belgium
230V, 3~, 50Hz/60Hz	25A	7.3 kW	–	
200V, 2~, 50Hz/60Hz	20A	3.3 kW	–	Japan
200V, 3~, 50Hz/60Hz	25A	6.9 kW	–	

UC-S

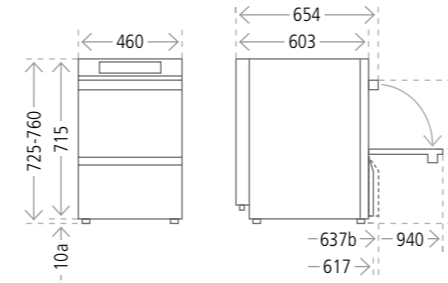

UC-S Energy

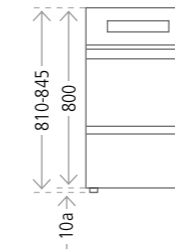

UC-S Excellence-i / UC-S Excellence-iPlus

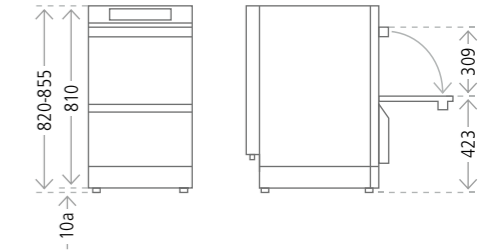

UC-M

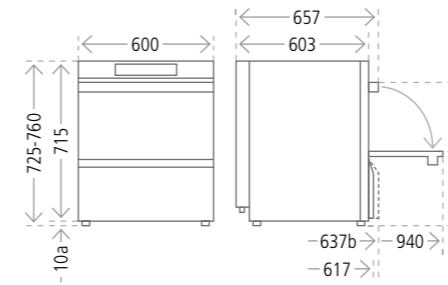

UC-M Energy

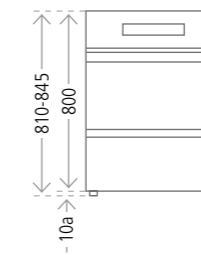

UC-M Excellence-i / UC-M Excellence-iPlus

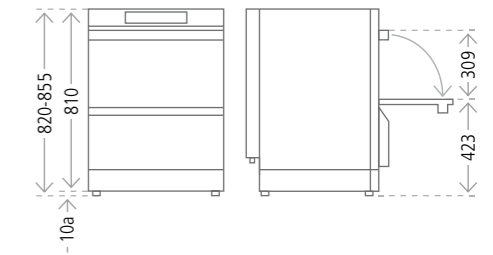

UC-L

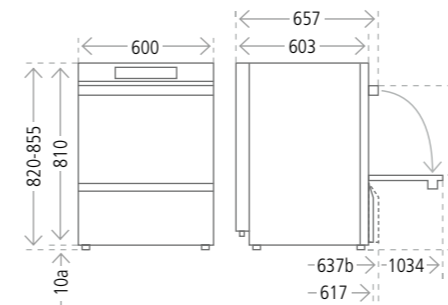

UC-L Energy

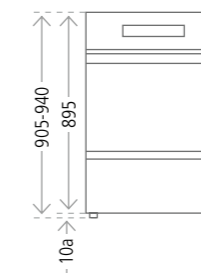

UC-XL

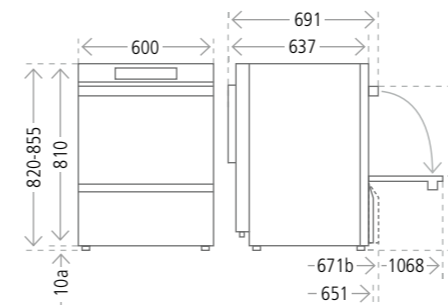

UC-XL Energy

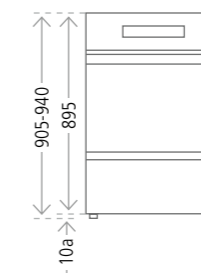

Note The following dimensions must be considered when installing the machine in a recess:

Height: + 5 mm
Width: + 10 mm
Depth: + 5 mm

a) Removing the feet reduces the machine height by 10 mm.
b) Without the build-in storage tanks for detergent and rinse aid, the depth reduces by 20 mm for all machines.

Further information can be found in our installation diagram.

*1 Depending on local conditions (inlet water temperature / electrical supply), the values stated here can be reduced.

*2 Non-binding information. The actual rinse water volume may vary depending on the on-site conditions.

*3 Depends on the inlet water temperature, switchable from 65 °C.

*4 Inlet water temperature < 20 °C.

*5 The actual connected load varies depending on the mains voltage.

OPTIONS AND ENHANCEMENTS

A SMARTER SOLUTION.

THE WINTERHALTER REUSABLE PLASTIC CUP WASHING SYSTEM

Reusable plastic cups washed clean. In less than two minutes. With guaranteed hygiene safety. The cup rack for the UC Series. Really easy to retrofit.



Takeaway coffee. Chai latte. Or herbal tea. From the café, the bakery or the service station. Operators of catering establishments often use reusable plastic cups to serve beverages. Until now, washing these cups in machines has been a problem: They tip over, fill up with water and dry badly. Winterhalter has now solved the problem and developed a professional solution: the reusable plastic cup washing system for the UC Series. This means that cups are washed hygienically clean in less than two minutes. And come out so dry that they can be stacked inside each other to save space.

You can find more information about reusable plastic cup washing at >> www.winterhalter.co.uk/reusable-cup-washing

THE ADVANTAGES

- ✓ Hygienically clean plastic cups in less than two minutes
- ✓ The best possible drying result
- ✓ Guaranteed hygiene safety
- ✓ Suitable for different cup sizes
- ✓ Cups are securely held in place in the rack
- ✓ Simple operation with an automatic rack safety lock

THE WINTERHALTER BOTTLE WASHING SYSTEM

Bottles washed clean. In less than a minute. For certified hygiene safety. The bottle rack for the UC Series. Really easy to retrofit.



Water in your own bottles or carafes. Filled from a tap or water dispenser. More and more restaurateurs serve water to their guests in this way – and require a warewashing solution for this. Winterhalter has developed a bottle rack and a special adapter; any UC Series warewasher can become a bottle-washing system. Water is injected into the bottle directly via a special jet. This provides cleaning quality and hygiene that is certified in accordance with DIN SPEC 10534. All UC Series warewashers can accommodate the bottle rack.

You can find more information about bottle washing at >> www.winterhalter.co.uk/bottle-washing

THE ADVANTAGES

- ✓ Up to 8 perfectly washed bottles in less than 1 minute
- ✓ Suitable for bottles with a base diameter of up to 100 mm
- ✓ Certified hygiene levels according to DIN SPEC 10534
- ✓ Switching operation is possible at any time – simply replace the bottom wash field with the bottle rack adapter
- ✓ Can be accommodated by all Winterhalter UC Series undercounter warewashers

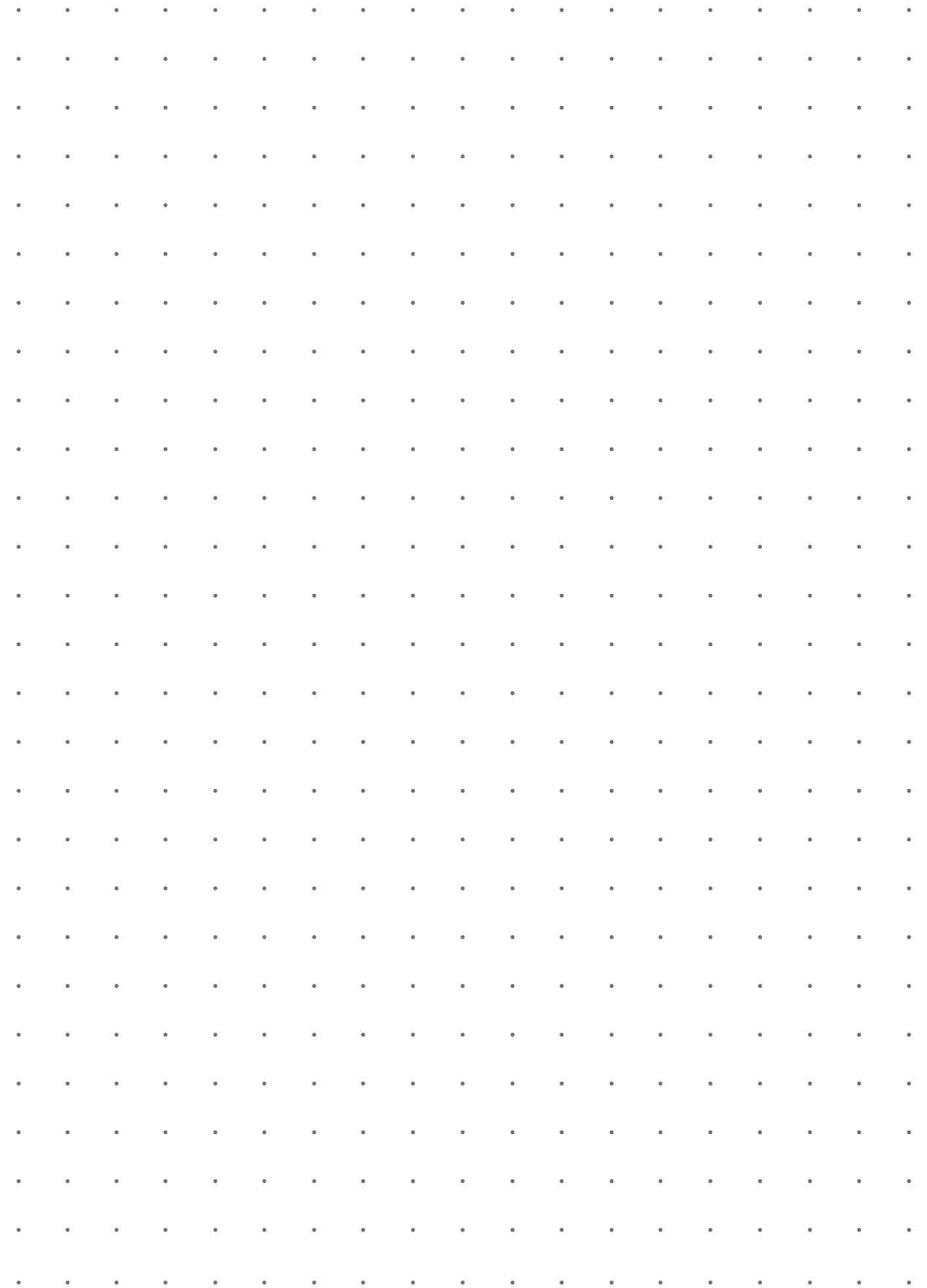

»In this brochure, we have presented our UC Series: its product features, application options and what sets it apart. However we were not able to provide you with the strongest argument of all here: the positive experiences of our satisfied customers. Just ask next time you see a UC anywhere. There is no better aid to making your decision.«

Jürgen and Ralph Winterhalter